

Ameda Elite® and HygieniKit® Operating & Cleaning Instructions

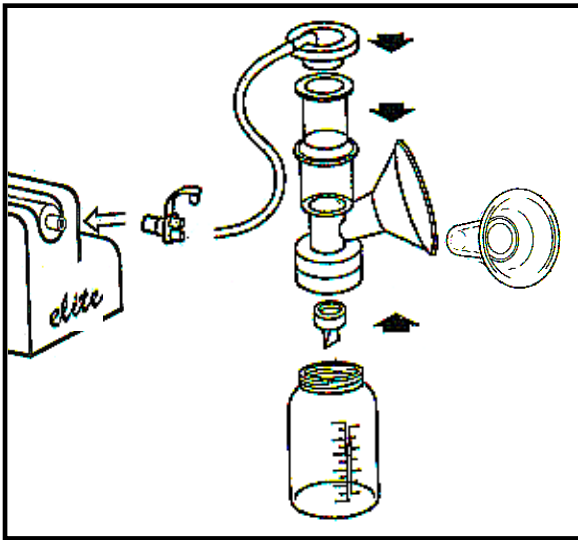

Assembling the Ameda HygieniKit®

To Single Pump

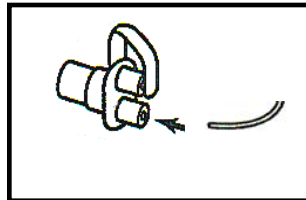

To Double Pump

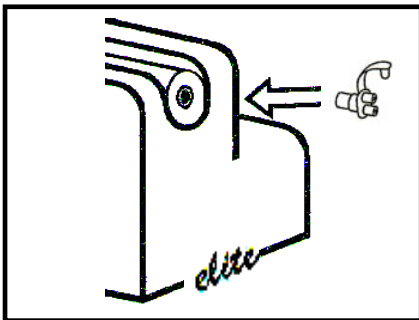
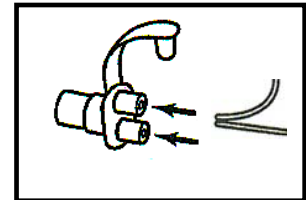

Operating the Ameda Elite® Electric Breast Pump

5. Assemble the Ameda HygieniKit® Milk Collection system as per the instructions included with the product.
6. Insert the tubing adaptor on the HygieniKit® Milk Collection System into the piston cylinder opening.
7. Centre your nipple(s) into the breast flange(s) of the HygieniKit® Milk Collection System.

Starting the Ameda Elite® Electric Breast Pump

4. Slowly, turn the vacuum dial to the right to the highest most comfortable for you. Note: High suction does not necessarily produce more milk.

Setting the Cycle Speed

1. Turn the cycle dial all the way to the right to help trigger the let – down reflex. Once your milk begins to flow, turn the dial back to the left.
2. As your milk begins to slow down, repeat step 5 to trigger more let-downs.
3. When finished pumping, turn the vacuum dial all the way to the left to turn pump off.

(Turn over for Cleaning Instructions)



Cleaning the Ameda HygieniKit[®]

After Use

Wipe over:

Tubing adaptor, tubing and adaptor cap.

Do not wash. These items do not require washing as they do not come in to contact with mothers' milk.

Wash gently:

Silicone diaphragm, pump body, valve, bottle and reducing insert, in warm soapy water.

Soak valve if required and rinse gently. Do not use bottle brush.

Place items for disinfection/sterilization according to hospital protocol.

IMPORTANT:

Sterilization instructions :

Hospital

For Polypropylene HygieniKits:

134 deg C for up to 5 mins

For Polycarbonate HygieniKits:

121 deg C for 15 mins

Home

Boil for 20 mins or wash in warm soapy water.

Air dry before assembly.

Cleaning the Elite:

Wipe Elite with hospital grade disinfectant with a damp cloth. If the cylinder needs to be detached

place the index finger into the tube and turn clockwise releasing it from the attachment.

Do not use abrasives or solvents.

Reinstall the cylinder as shown in the picture, In attachment points ① and ②. Press and click in place.

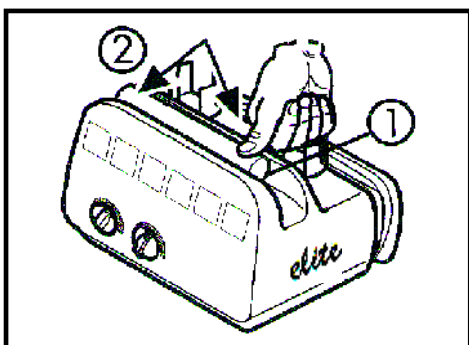
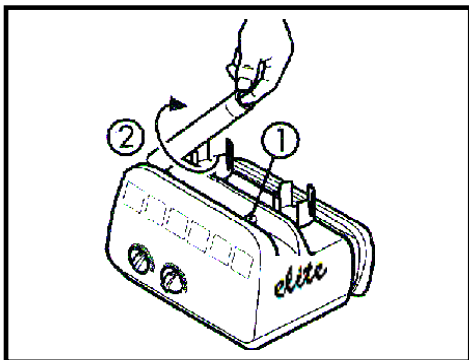
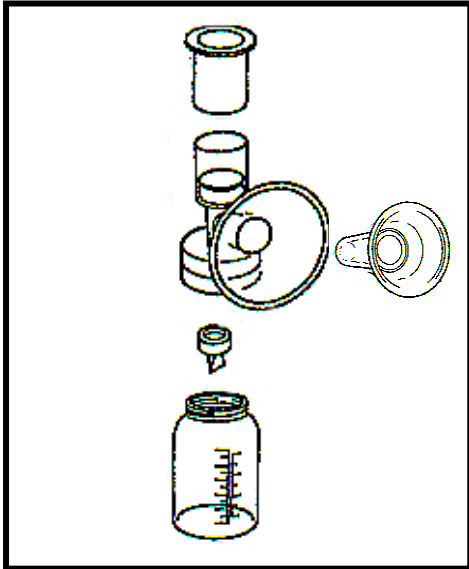
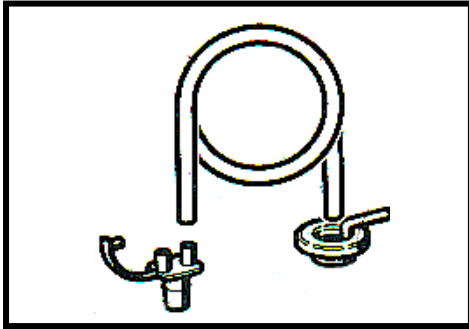

(See over for Operating Instructions)